

NEW

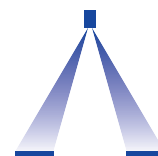

Twin flat spray nozzles XDT 130



Crop production / Ground care

- Extreme drift reduction over the entire pressure range
- Symmetrical twin flat spray jet 40°/40° to the front/rear

Advantages

- High workrate due to wide control range
- Optimum deposition with reduced spray shadow
- Nozzle in cap with MULTIJET bayonet system (incl. gasket)
- For timely application even under adverse weather conditions
- Suitable for PWM



Series XDT 130



Dosing orifice with basket, can be removed without tools

Dimensions in mm.

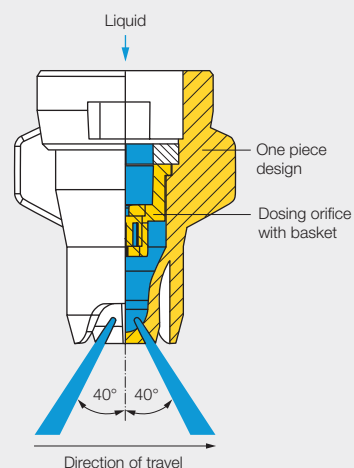
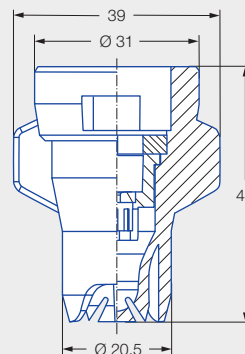

Application:



Plant protection products



Golf course

Technical data:



Nozzle sizes
02-08



Spray angle
130°



Material
POM



Pressure ranges
1.5-8 bar



Recommended strainers
60 M 02-08





Droplet sizes
Ultra coarse - extremely coarse



Altek International Ltd
Tel: 01652 688889
Email: info@altekinternational.com



			[l/min]	[l/ha] 							
				5.0 km/h	6.0 km/h	7.0 km/h	8.0 km/h	10.0 km/h	12.0 km/h	14.0 km/h	16.0 km/h
XDT 130-02 (60 M)	1.5	0.56	134	112	96	84	67	56	48	42	37
	2.0	0.65	156	130	111	98	78	65	56	49	43
	3.0	0.80	192	160	137	120	96	80	69	60	53
	4.0	0.92	221	184	158	138	110	92	79	69	61
	5.0	1.03	247	206	177	155	124	103	88	77	69
	6.0	1.13	271	226	194	170	136	113	97	85	75
	7.0	1.22	293	244	209	183	146	122	105	92	81
	8.0	1.30	312	260	223	195	156	130	111	98	87
XDT 130-025 (60 M)	1.5	0.70	168	140	120	105	84	70	60	53	47
	2.0	0.81	194	162	139	122	97	81	69	61	54
	3.0	0.99	238	198	170	149	119	99	85	74	66
	4.0	1.15	276	230	197	173	138	115	99	86	77
	5.0	1.28	307	256	219	192	154	128	110	96	85
	6.0	1.40	336	280	240	210	168	140	120	105	93
	7.0	1.52	365	304	261	228	182	152	130	114	101
	8.0	1.62	389	324	278	243	194	162	139	122	108
XDT 130-03 (60 M)	1.5	0.84	202	168	144	126	101	84	72	63	56
	2.0	0.97	233	194	166	146	116	97	83	73	65
	3.0	1.19	286	238	204	179	143	119	102	89	79
	4.0	1.37	329	274	235	206	164	137	117	103	91
	5.0	1.53	367	306	262	230	184	153	131	115	102
	6.0	1.68	403	336	288	252	202	168	144	126	112
	7.0	1.81	434	362	310	272	217	181	155	136	121
	8.0	1.94	466	388	333	291	233	194	166	146	129
XDT 130-04 (60 M)	1.5	1.12	269	224	192	168	134	112	96	84	75
	2.0	1.29	310	258	221	194	155	129	111	97	86
	3.0	1.58	379	316	271	237	190	158	135	119	105
	4.0	1.82	437	364	312	273	218	182	156	137	121
	5.0	2.04	490	408	350	306	245	204	175	153	136
	6.0	2.23	535	446	382	335	268	223	191	167	149
	7.0	2.41	578	482	413	362	289	241	207	181	161
	8.0	2.58	619	516	442	387	310	258	221	194	172
XDT 130-05 (60 M)	1.5	1.39	334	278	238	209	167	139	119	104	93
	2.0	1.61	386	322	276	242	193	161	138	121	107
	3.0	1.97	473	394	338	296	236	197	169	148	131
	4.0	2.28	547	456	391	342	274	228	195	171	152
	5.0	2.55	612	510	437	383	306	255	219	191	170
	6.0	2.79	670	558	478	419	335	279	239	209	186
	7.0	3.01	722	602	516	452	361	301	258	226	201
	8.0	3.22	773	644	552	483	386	322	276	242	215
XDT 130-06 (60 M)	1.5	1.67	401	334	286	251	200	167	143	125	111
	2.0	1.93	463	386	331	290	232	193	165	145	129
	3.0	2.36	566	472	405	354	283	236	202	177	157
	4.0	2.73	655	546	468	410	328	273	234	205	182
	5.0	3.05	732	610	523	458	366	305	261	229	203
	6.0	3.34	802	668	573	501	401	334	286	251	223
	7.0	3.61	866	722	619	542	433	361	309	271	241
	8.0	3.86	926	772	662	579	463	386	331	290	257
XDT 130-08 (60 M)	1.5	2.23	535	446	382	335	268	223	191	167	149
	2.0	2.58	619	516	442	387	310	258	221	194	172
	3.0	3.16	758	632	542	474	379	316	271	237	211
	4.0	3.65	876	730	626	548	438	365	313	274	243
	5.0	4.08	979	816	699	612	490	408	350	306	272
	6.0	4.47	1,073	894	766	671	536	447	383	335	298
	7.0	4.83	1,159	966	828	725	580	483	414	362	322
	8.0	5.16	1,238	1,032	885	774	619	516	442	387	344

- Operating pressure at the nozzle (measured with diaphragm valve)
- The stated liter-per-hectare rates apply to water
- Verify the table values by gauging the flow rates prior to every spraying season
- Pay attention to uniform nozzle adjustment

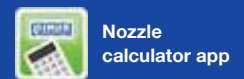

The apps for Lechler agricultural nozzles make selection and use of the optimum nozzle even easier. Find out more here: www.lechler.com/de-en/service/apps



Ordering Series + Nozzle size + Material = Order No.
example: XDT 130 + 02 + (POM) = XDT 130-02



Altek International Ltd
Tel: 01652 688889
Email: info@altekinternational.com

